

REVISION HISTORY	
1	Original Part
	Table update

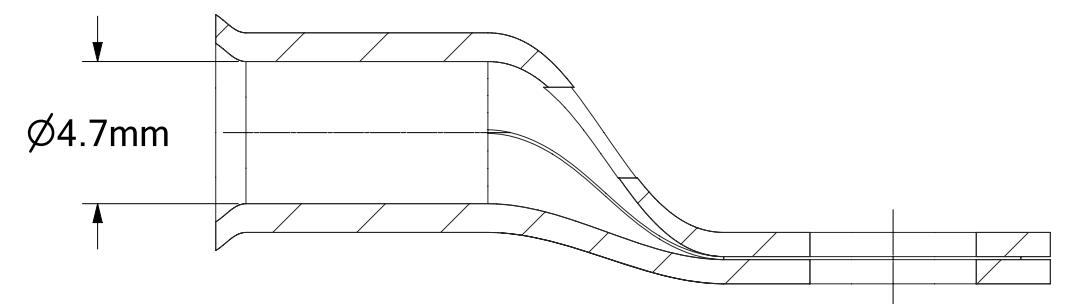

SECTION A-A

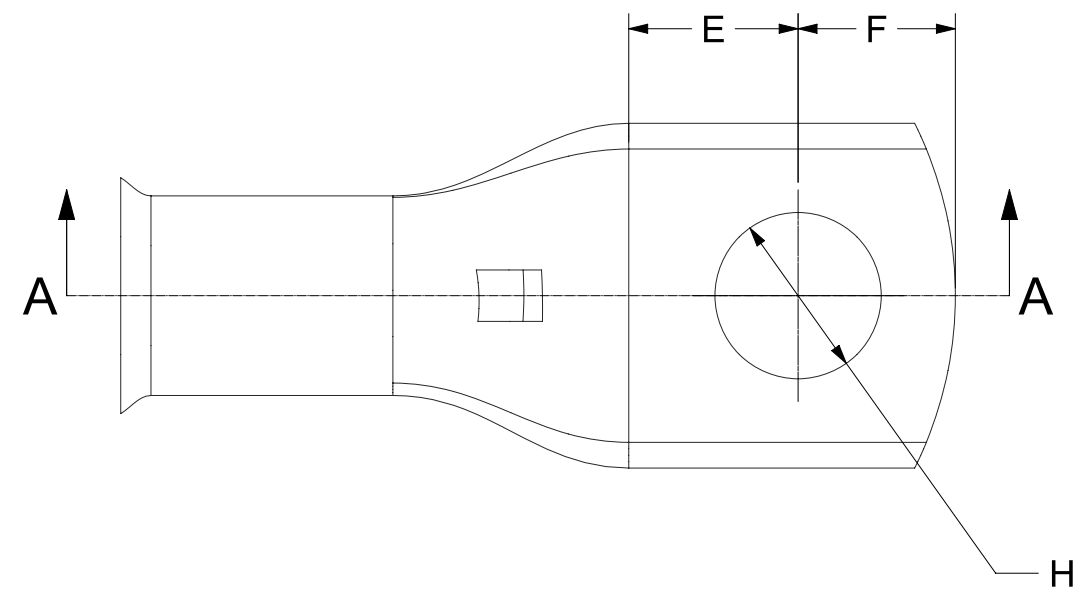
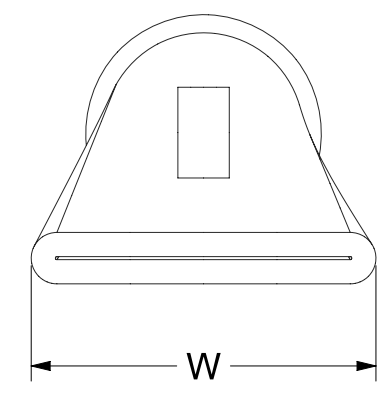

PART NO.	H (mm)	E (mm)	F (mm)	W (mm)
TCSD-10-0	0	N/A	20.5	16.0
TCSD-10-5	5.5	5.6	5.2	11.0
TCSD-10-6	6.5	5.6	5.2	11.0
TCSD-10-8	8.5	8.0	7.0	13.0
TCSD-10-10	10.5	10.9	9.6	16.0
TCSD-10-12	12.5	10.5	10.0	18.0

UOS - LINEAR TOLERANCE PERMISSABLE DEVIATIONS FOR SIZE RANGE:
Tolerances according to DIN ISO 2768 (V)

DIMS IN MM	0.5 to 3	>3 to 6	>6 to 30	>30 to 120	>120 to 400	>400 to 1000	>1000 to 2000	>2000 to 4000
	-	±0.5	±1.0	±1.5	±2.5	±4.0	±6.0	±8.0



Total Connections 2009 LTD
www.tc2009.co.uk
sales@tc2009.co.uk
Tel 01249 812 707

Drawing No. TCDR1919

Material. CW024A (C106) COPPER

Part No. TCSD-10-RANGE

Finish. 5MICRON ELECTRO TIN PLATED

SIZE A3	Date 21/10/2021	Created By: Dan Hewlett	REV 2
------------	--------------------	----------------------------	----------

SCALE 4:1 SHEET 1 of 1